



® ANARIC

feel home

2012 edition

® ANARIC



# The essence of the future is in every one of us.

Anaric faz a ligação do passado ao futuro, numa verdadeira expressão de memória e prazer.

A busca constante pelo equilíbrio perfeito entre disciplina, criatividade, qualidade e elegância é permanentemente gravada nos produtos ANARIC.

A coleção 2012 reflete o espírito SENTIR-SE EM CASA. Uma coleção com alguma inspiração nos anos 60/70, num estilo retro/vintage, onde cada elemento adapta-se a estilos de vida bem ativos.

Nesta coleção pode-se encontrar sofás e peças modulares, onde a nossa experiência é revelada nos detalhes.

Uma coleção para espaços abertos, inteiramente voltada para as influências globais, envolvendo vários géneros e ideias de todo o mundo.

Anaric connect past and future in a true expression of memorie and plasure.

The constant searching for a perfect balance between discipline, creativity, quality and elegance is permanently engraved in ANARIC products.

The 2012 collection reflects the spirit: FEEL HOME. A collection inspired by the 60's/70's, style retro/vintage, where each element adapts to active lifestyles. In this collection you can find sofas and modular pieces, where our experience is revealed in the details.

A collection for open spaces, devoted entirely to global influences, involving genres and ideas from around the world.

2012 edition

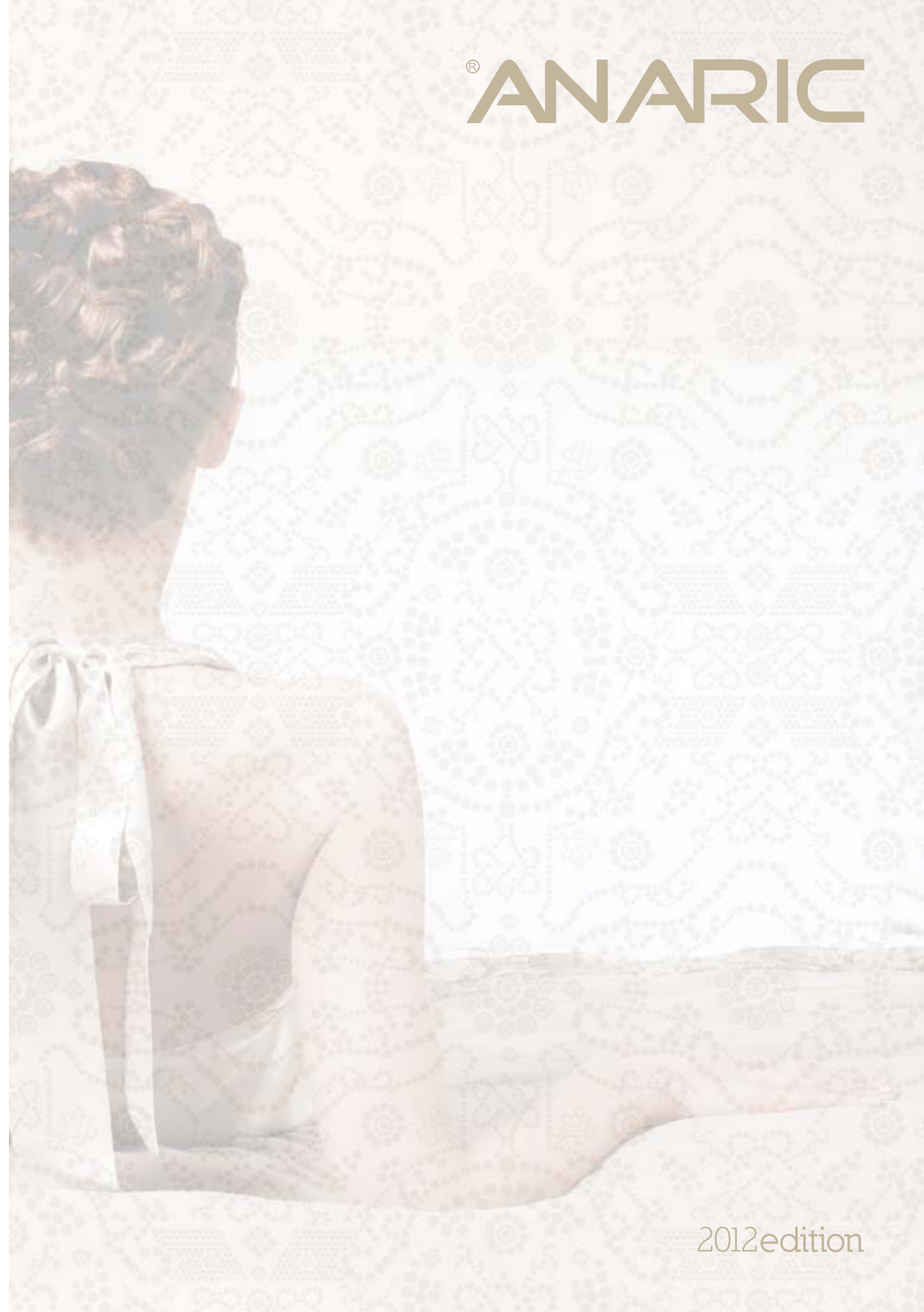



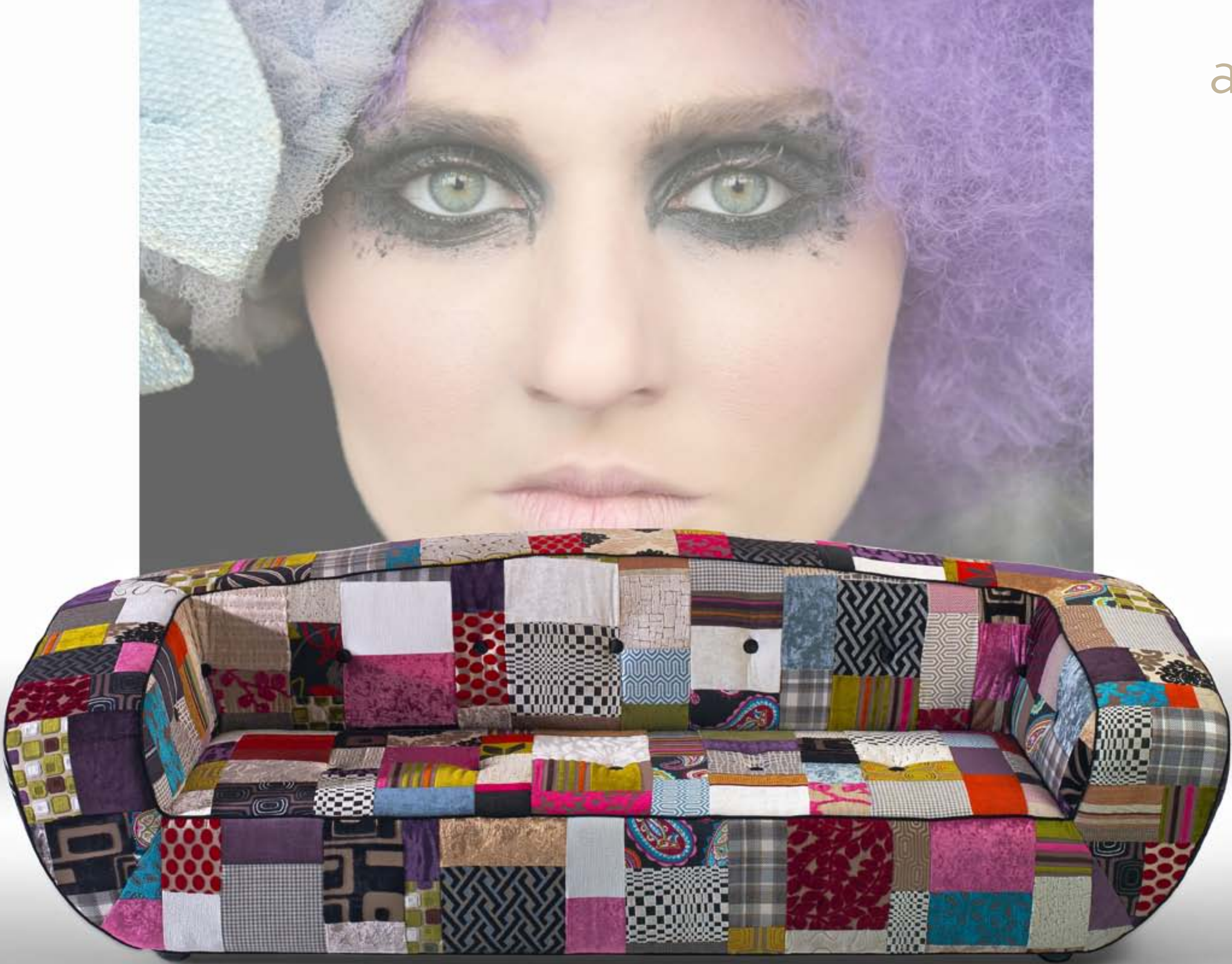



# anori



O sofá ANORI evita o puro narcisismo a favor de um design funcional e uma forte identidade pessoal. A conjugação de vários tecidos torna-o numa peça única.

Adquirir um ANORI é ter uma experiência exclusiva.

The ANORI sofa avoids pure narcissism in favour of functional design and a strong personal identity. The combination of various fabrics makes this a single piece.

ANORI is to have a unique experience.

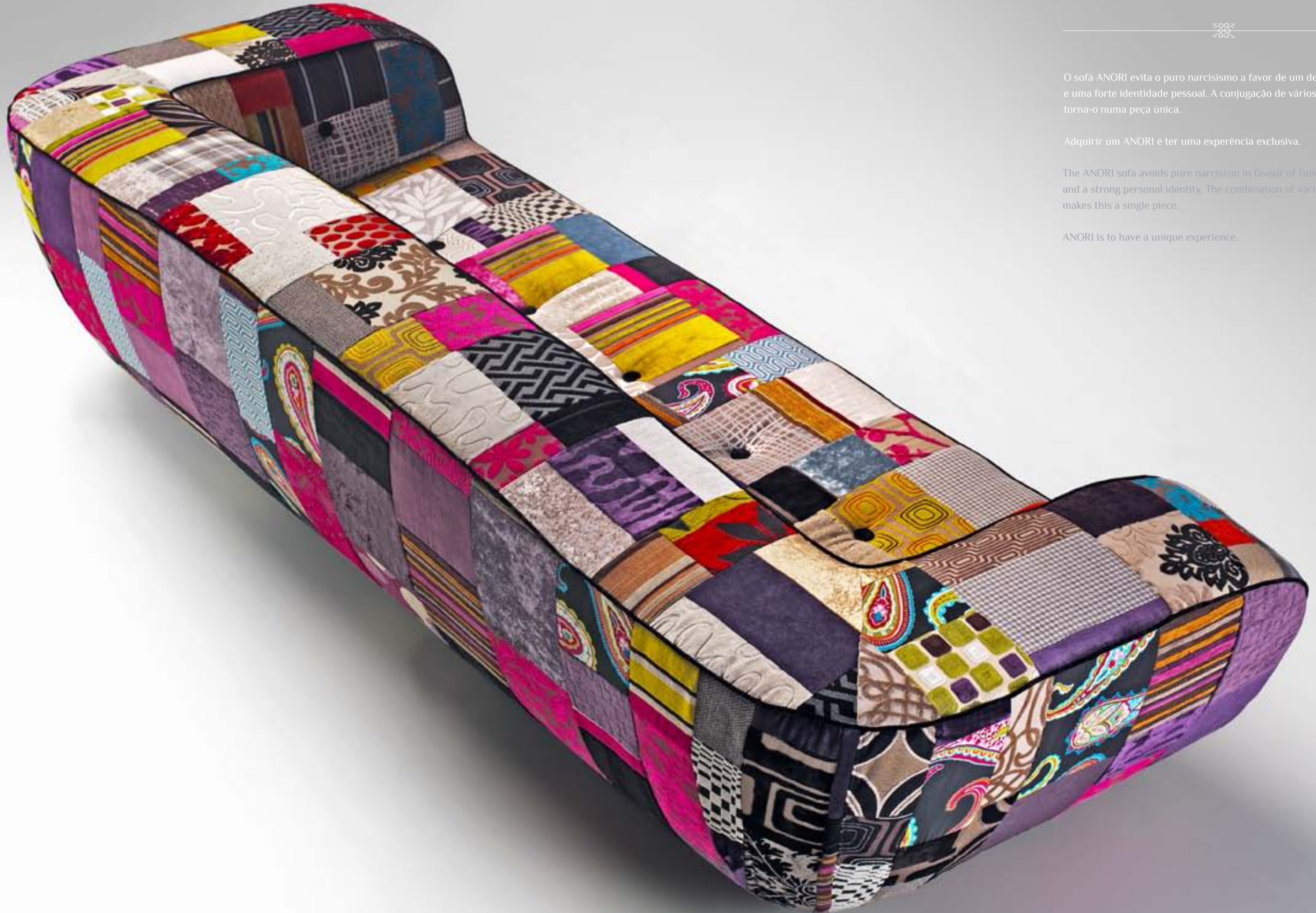



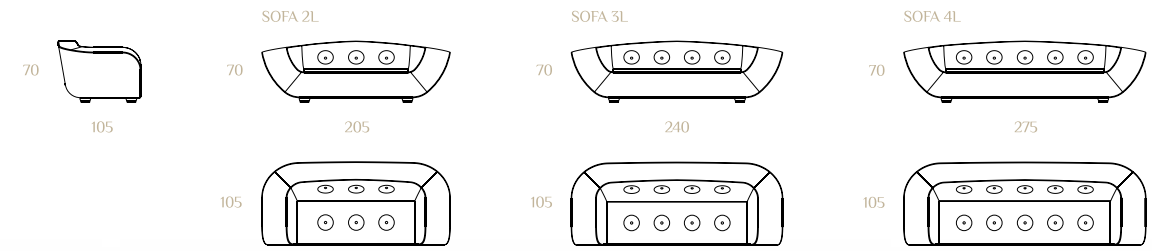



# walter



A essência do conforto e inovação.  
Sistema de audio integrado no módulo angular. Alta qualidade de som  
stéreo, com base para iPod/iPhone/USB/Cartão de memória.  
Oferece uma experiência única para relaxar. Este sofá é testado  
ergonomicamente.

The essence of confort and innovation.  
High quality Stereo Sound Audio System integrated in the corner  
module with iPod/iPhone/USB/Memory card docking station.  
Offers a unique experience for relaxation. This sofa its ergonomically  
tested for confort.



walter

SOFA 3L com braço + ELEM. canto + ELEM. chaise

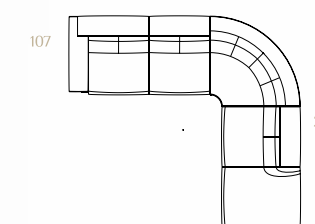
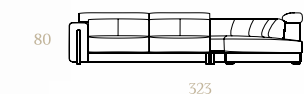







SOFA 3L com braço + chaise long 3L

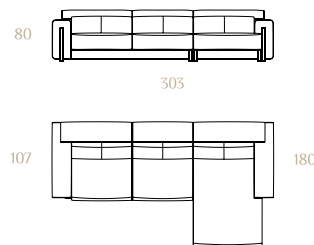



walter









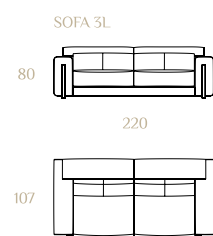



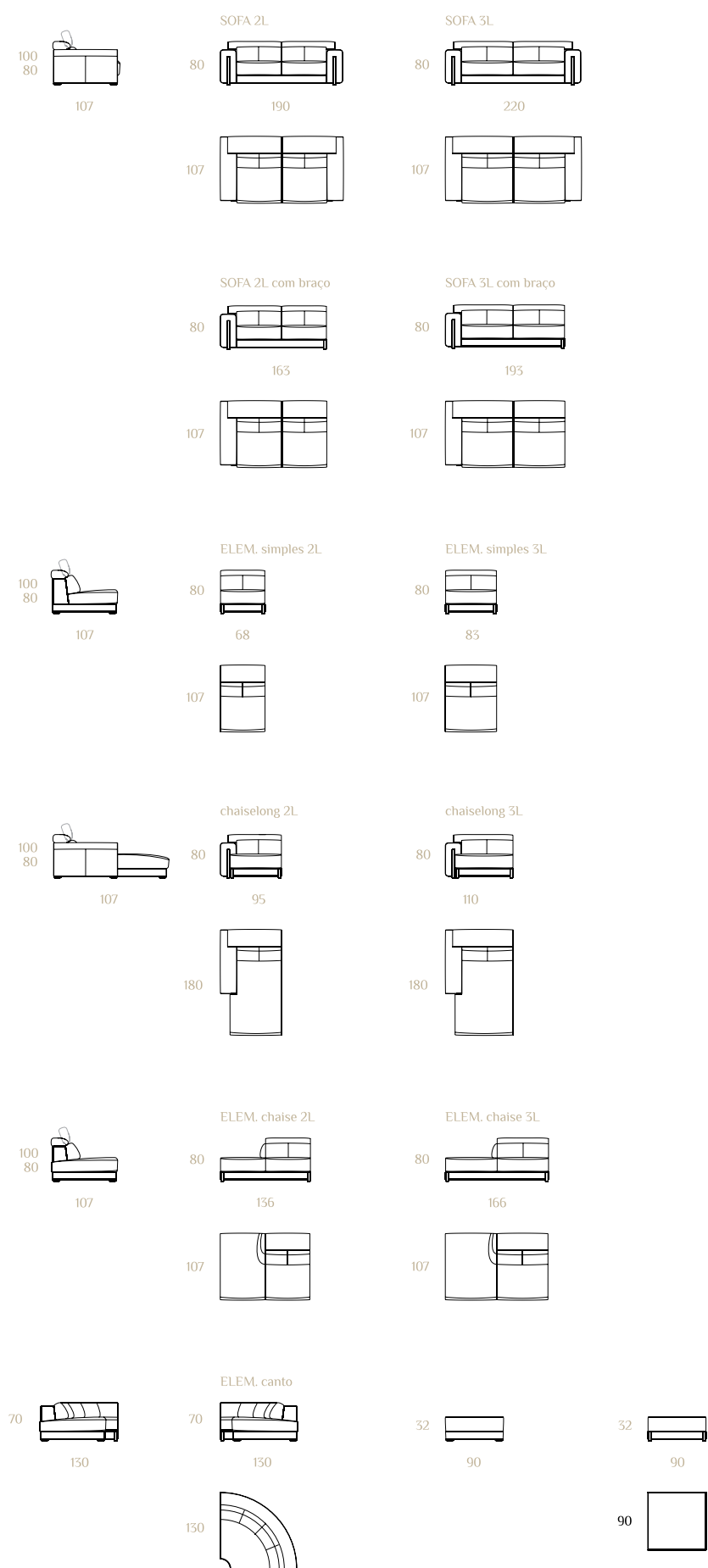



# santana



Um sofá com uma silhueta clássica, perfeito para contrastes em ambientes modernos e contemporâneos.

Da arte de ser feito manualmente, onde o principal destaque resulta num braço em madeira que se interliga com o estofado de forma singular.

A sofa with a classic silhouette, perfect for contrasts in modern environments and contemporaries.

From art to be done manually where the main emphasis results in a wooden arm that connects with the upholstery in a unique way.





# santana

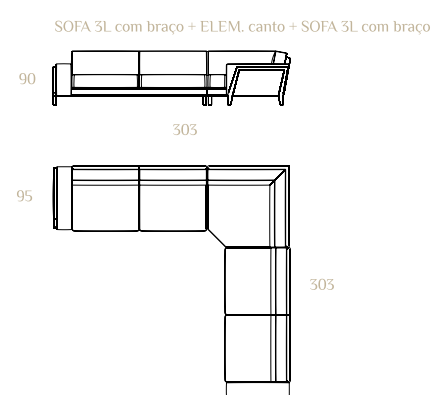
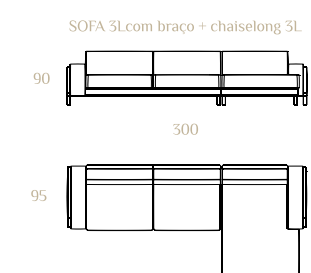







santana

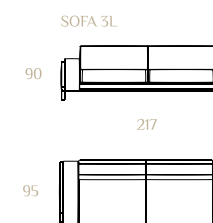



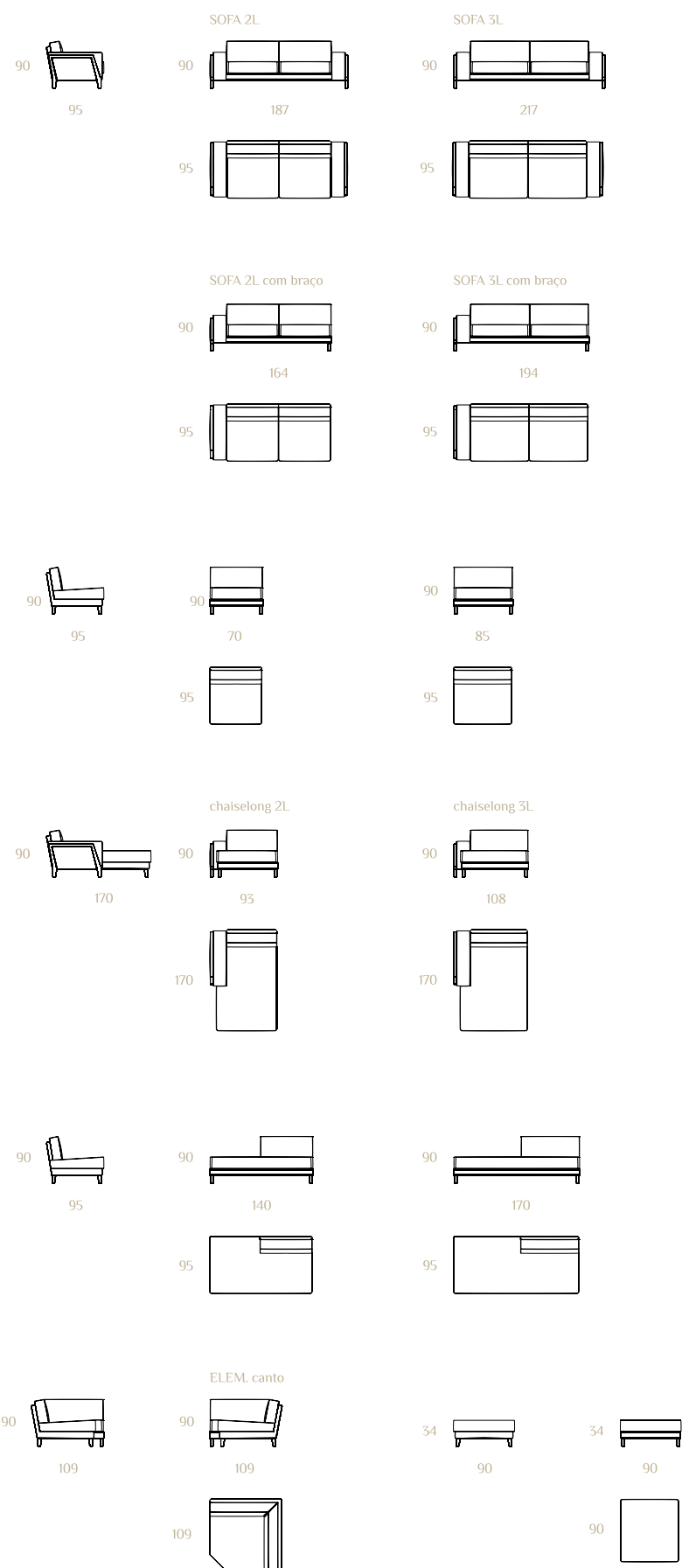



klint





SOFA 3L com braço + ELEM. canto + SOFA 3L com braço

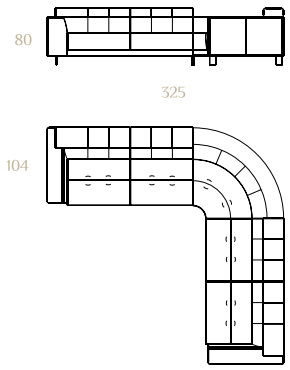

klint





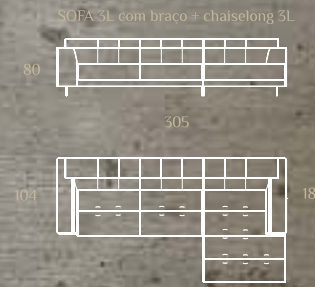



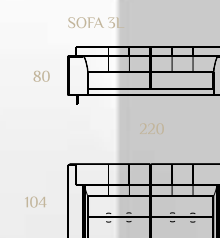



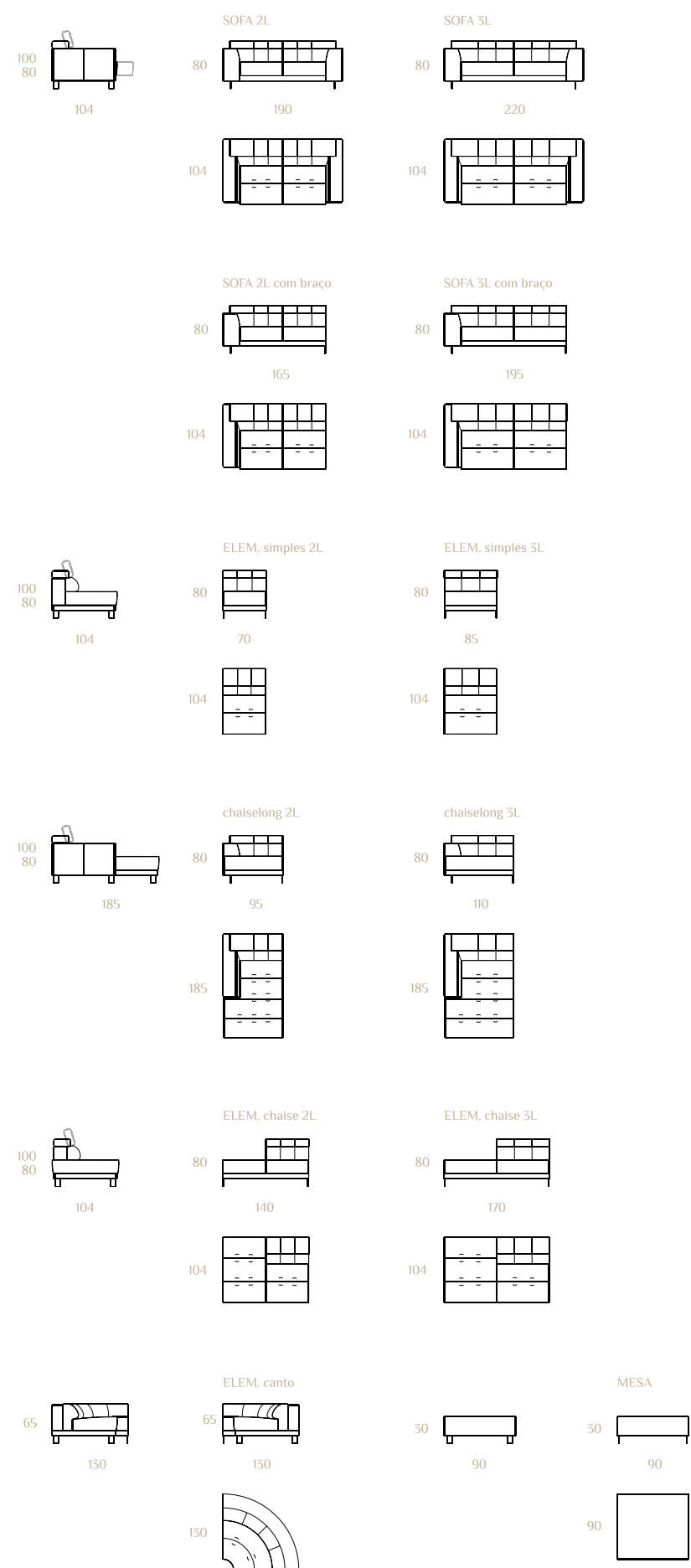

DESIGN PRODUTO  
Emanuel José

DESIGN GRÁFICO  
Galliotta Design

FOTOGRAFIA  
Carlos Ferraz  
Joaquim Ferraz

IMPRESSÃO  
Greca

AGRADECIMENTOS  
Go Home  
Casa R  
100% Interiores  
Efeito Capitonê

Rua das Mimosas | Ervedosa | 4510-329 S.Pedro da Cova  
Gondomar | Portugal  
TEL. +351 22 466 4090 | FAX +351 22 466 4099  
anaric@anaric.pt

[www.anaric.pt](http://www.anaric.pt)

® ANARIC

feel home



2012 edition



[www.anaric.pt](http://www.anaric.pt)

